



# HEAT CONTROLLER

---

## **Owner's Manual**

### **VMH 30/36 SD Series**

Inverter Single Zone

Ductless Mini-Split

## **CONTENTS**

### **SAFETY PRECAUTIONS**

Warning .....	1
Caution .....	2

### **NAMES OF PARTS**

Indoor unit .....	3
outdoor unit .....	3
Indication lamp.....	3

### **OPERATING INSTRUCTIONS**

Special functions .....	4
Operating temperature.....	5
Manual operation .....	5
Airflow direction control .....	6
How the air conditioner works .....	7

### **CARE AND MAINTENANCE**



Before maintenance.....	8
Cleaning the air filter and air freshening filter .....	8
Replacement of the air filter and air freshening filter .....	9
Preparation for extended non-operation.....	9
Pre-season inspection.....	9

### **TROUBLESHOOTING TIPS**



Normal function of the air conditioner.....	10
Troubleshooting guide .....	12

## SAFETY PRECAUTIONS

To prevent injury to the user or other people and property damage, the following instructions must be followed. Incorrect operation due to ignoring of instructions may cause harm or damage. The seriousness is classified by the following indications.

 <b>WARNING</b>	This symbol indicates the possibility of death or serious injury.
 <b>CAUTION</b>	This symbol indicates the possibility of injury or damage to property.

■ Meanings of symbols used in this manual are as shown below.

	<b>Strictly prohibited.</b>
	<b>Be sure to follow the instructions.</b>

### **WARNING**



- Do not extend the cable and never use multiple plugs. A poor electrical connection, poor insulation or voltage which is higher than permitted can cause fire.
- Do not expose your body directly to the cool air for prolonged periods.
- Never poke fingers, sticks or other objects in the air inlet and outlet vents.
- Never attempt to repair, relocate, modify the air conditioner yourself. Always contact your service partner if required.
- Never pull the plug out by pulling on the cable. Hold the plug firmly and pull it out of the plug socket, otherwise there is a risk of damaging the cable.
- Do not operate your air conditioner in a wet room such as a bathroom or laundry room.



- Remove all dirt from the power plug and plug it firmly. Soiled plugs can cause fire or an electric shock.
- In the event of any abnormalities such as smell of burning, immediately switch off the device and pull the plug. Contact your service partner.
- Always switch off the device and pull the plug before you clean it.
- Use specified power cord.
- Contact an authorized installer for installation of this unit.
- Contact an authorized service technician for repair or maintenance of this unit. This appliance is not intended for use by persons (including children) with reduced physical, sensory or mental capabilities, or lack of experience and knowledge, unless they have been given supervision or instruction concerning use of the appliance by a person responsible for their safety.
- Children should be supervised to ensure that they do not play with the air conditioner.

**SAFETY PRECAUTIONS** **CAUTION**

- Never actuate any switches with a wet hand. It may cause an electric shock. Never use the device for any other purpose than the intended use.
- Never place food, precision instruments, plants, animals, paint, etc. on the unit.
- Do not expose plants or animals directly to the air flow.
- Never clean the air conditioner with water. Never use combustible cleaning agents as these could cause a fire or deformation.
- Never place any burning objects close to the device if they could be directly affected by the emitted air.
- Never step onto the outdoor device and never place anything on it. Never use an unsteady or rusty base.
- Never install the air conditioner in places where combustible gas can be emitted. Emitted gas may collect and cause an explosion.
- Never allow the air conditioner to run for too long with the doors or windows open, or if the humidity is very high.



- If the air conditioner is to be used in conjunction with other heaters, the air should be refreshed periodically, otherwise there is a risk of lack of oxygen.
- Always switch off the air conditioner switch off disconnect during a storm. Electrical parts may get damaged.
- Check that the drainage line is correctly connected. If not, water will escape.
- Check that the condensation water can run off unhindered. It may cause water damage if the condensation water cannot run off properly.
- The air conditioner must be earthed in accordance with the local codes.
- For electrical safety purposes we recommend that you install an earth-leakage circuit-breaker.
- If the power cord is damaged, it must be replaced by the manufacturer, its service agent or similar qualified persons in order to avoid a hazard.

**NAMES OF PARTS**

**Indoor unit**

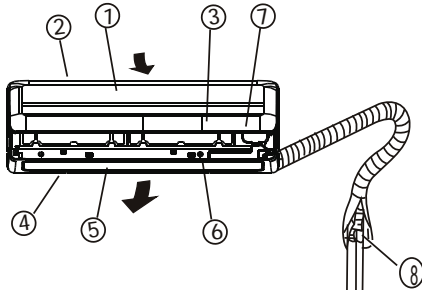

**Outdoor unit**

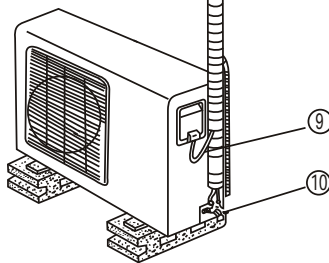

**Names of parts**

**Indoor unit**

1. Front panel
2. Air inlet
3. Air filter
4. Air outlet
5. Horizontal air flow grille
6. Vertical air flow louver(inside)
7. Display panel

**Outdoor unit**

8. Connecting pipe
9. Connecting cable
10. Stop valve

**NOTE:**

All the pictures in this manual are for explanation purposes only. The actual shape of the indoor unit you purchased may be slightly different on front panel and display window. The actual shape shall prevail.

**Indication lamp**

**NOTE:** The display on the indoor unit you purchased may look like one of the following:



(A)

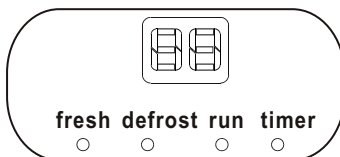

(B)

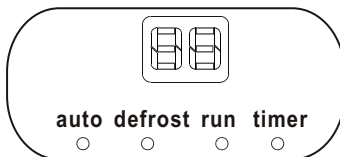

(C)

**Indication lamp**

**FRESH indication lamp** (optional function)

This lamp illuminates when Clean Air feature is activated.

**AUTO indication lamp**

Lights up under auto operation..

**DEFROST indication lamp**

(Applicable to cooling & heating models only):

Lights up when the air conditioner starts defrosting automatically or when the warm air control feature is activated in heating operation.

**RUN indication lamp**

This lamp illuminates when the air conditioner is in operation.

**TIMER indication lamp**

Lights up during Timer operation.



**Temperature indicator**

- Displays the temperature settings when the air conditioner is operational.
- Displays the malfunction code.

## OPERATING INSTRUCTIONS

*Displays the special functions in the following ways(for some models only):*

- Displays 'ON' for three seconds when Timer ON, Fresh, Swing, Turbo or Silence feature is activated.
- Displays 'OF' for three seconds when Timer OFF is set.
- Displays 'OF' for three seconds when Fresh, Swing, Turbo or Silence feature is cancelled.
- Displays 'dF' under defrosting operation.
- Displays 'eF' when anti-cold air feature is activated under heating mode.
- Displays 'SC' during self clean operation(if applicable).
- Displays 'FP' under 8°C heating operation(if applicable).

### **Special functions**

#### **Refrigerant Leakage Detection(optional):**

With this new technology, the display area will appear EC and the indication lamps continue flashing when the outdoor unit detects refrigerant leakage.

#### **Louver Angle Memory Function(optional):**

Within the scope of safety angle, it will memorize the open angle of horizontal louver. If it exceeds, it will memorize the boundry of safety angle. In the following circumstances, it will return to standard angle: 1) pressing the manual switch, 2) unplug and then plug in the machine. We strongly suggest that the open angle of the horizontal louvers should not be set too small, in case the condensed water forms and drips from the horizontal louver.

#### **SELF CLEAN function(optional):**

- Function used after the Shut Down of cooling operation to clean the Evaporator and keep it fresh for the next operation.
- The unit will operate according to following sequence : FAN ONLY mode at Low fan speed--Heating operation with LOW fan speed (applicable to cooling & heating models only) ---FAN ONLY operation--Stop Operation---Turn off.

#### **Note:**

- This function is only available under COOL(AUTO COOL, FORCED COOL) and DRY mode. operation for about half an hour. Once the Self Clean function is activated, all TIMER settings will be canceled.
- During Self Clean operation, pressing the SELF CLEAN button on the remote controller again will stop operation and turn off the unit automatically.

#### **CLEAN AIR function(optional):**

This air conditioner is equipped with ionizer or Plasma Dust Collector(Depending on specific configuration of the model). With the anions generated by Ionizer, the air circulation of the air conditioner fills the room with refreshing, natural and healthy air. The Plasma Dust Collector generates a high voltage ionization zone, through which the air is converted to plasma. Inside the air most of the dust, smoke, and pollen particles are captured by the electrostatic filter.

#### **Vertical swing function(optional):**

After the air conditioner starts up, users can control the vertical louver swing by the remote controller.

**OPERATING INSTRUCTIONS**

**NOTE:** This manual does not include Remote Controller Operations, see the <<Remote Controller Instruction>> packed with the unit for details.

**Operating temperature**

Mode	Cooling operation	Heating operation	Drying operation
Room temperature	62°F~90°F (17°C~32°C)	32°F~86°F (0°C~30°C)	50°F~90°F (10°C~32°C)
Outdoor temperature	32°F~122°F (0°C~50°C)	5°F~86°F (-15°C~30°C)	32°F~122°F (0°C~50°C)
	5°F~122°F (-15°C~50°C) temperature cooling system		

**NOTE:**

- Optimum performance will be achieved within these operating temperatures. If air conditioner is used outside of the above conditions, certain safety protection features might come into operation and cause the unit to function abnormally.
- If the air conditioner runs for a long time in cooling mode and the humidity is high(over 80%) , condensed water may drip out of the unit. Please set the vertical air flow louver to its maximum angle (vertically to the floor), and set HIGH fan mode.

**Suggestion:** Single this unit uses an Electric Heater, when the outside ambient temperature is below (32°F) 0°C, we strongly recommend you to keep the machine plugged in order to guarantee it running smoothly.

**Manual operation**

Units are equipped with a switch to run emergency operation mode. It can be accessed by opening the front panel. This switch is used for manual operation in case the remote controller fails to work or maintenance is necessary.

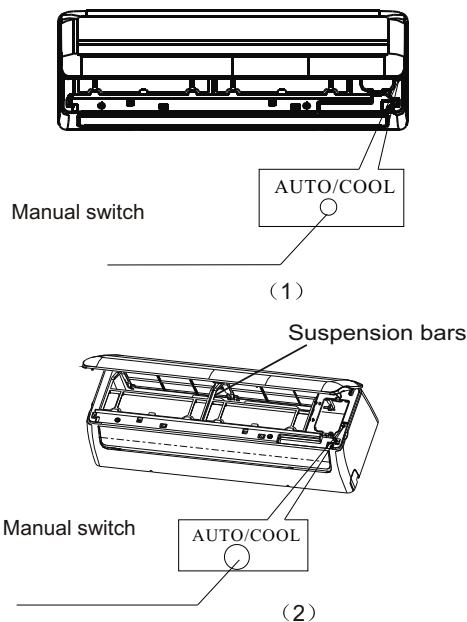

**NOTE:** The unit must be turned off before operating the manual control button. If the unit is operational, continue pressing the manual control button until the unit is off.

- Open and lift the front panel up to an angle where it remains fixed with a clicking sound.
- One press of the manual control switch will lead to the forced AUTO operation. Press the switch twice within five seconds, the unit will operate under forced COOL operation.
- Close the panel firmly to its original position.

**CAUTION:**

- This switch is used for testing purposes only. To restore the remote controller operation, use the remote controller directly.

## OPERATING INSTRUCTIONS

### Airflow direction control

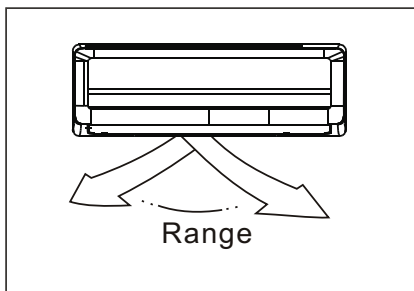
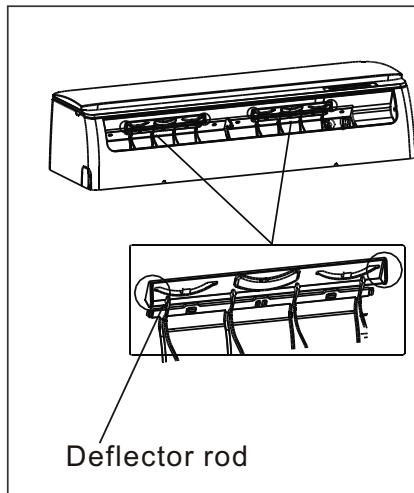
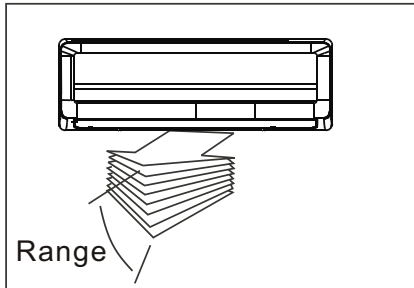

Adjusting the air flow direction improperly can cause discomfort or cause uneven room temperatures. Adjust the horizontal/vertical louver using the remote controller. For some models, the vertical louver can only be adjusted manually.

#### To set the horizontal/vertical air flow direction

- Perform this function while the unit is in operation.
- Use the remote controller to adjust the air flow direction. The vertical/horizontal louver changes 6 degree in angle for each press, or swings up and down automatically. Please refer to the ‘REMOTE CONTROLLER OPERATION MANUAL’ for details.
- For some models, the vertical louver can only be adjusted manually. Move the deflector rod manually to adjust the air flow in the direction you prefer.

**IMPORTANT:** Do not put your fingers into the louver area. The high-speed fan inside may cause injury.

#### **⚠ CAUTION**

- Do not operate the air conditioner for long periods with the air flow direction set downward in cooling or dehumidifying mode. Otherwise, condensation may occur on the surface of the horizontal louver causing moisture to drop on to the floor or on furnishings.
- When the air conditioner is started immediately after it was stopped, the horizontal louver might not move for approximately 10 seconds.
- Open angle of the horizontal louver should not be set too small, as COOLING or HEATING performance may be impaired due to too restricted air flow area.
- Do not move the horizontal louver manually, otherwise the horizontal louver will be out of sync. Please cease operating, unplug power for a few seconds, then restart the air conditioner.
- Do not operate unit with horizontal louver in closed position.

If the horizontal louver becomes out of sync, perform the following:

1. Turn unit on (Heat, cool, or fan)
2. Manually close louver.
3. Turn unit off. This will reset the louver position.



**How the air conditioner works**

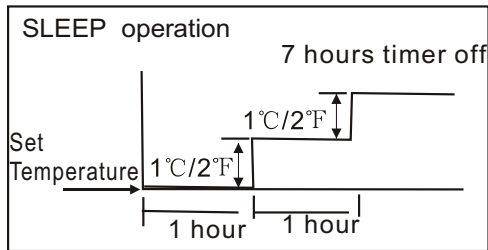

**Cooling**

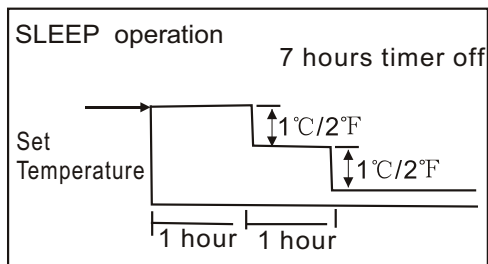

**Heating**

**AUTO operation**

- When you set the air conditioner in AUTO mode, it will automatically select cooling, heating(cooling/heating models only), or fan only operation depending on set temperature and the room temperature.
- The air conditioner will control room temperature automatically to the temperature point you set.
- If you feel uncomfortable in the AUTO mode, you can set your desired temperature.

**SLEEP operation**

When you push SLEEP button on remote controller during cooling, heating(cooling & heating models only), or AUTO operation , the air conditioner will automatically increase (cooling) or decrease (heating) 1°C/2°F per hour for the first 2 hours, then hold steadily for the next 5 hours, after that it will switch off. This mode saves you energy and brings you comfort at night.

**DRYING operation**

- The fan speed will be automatically controlled under dry operation.
- During the dry operation, if the room temperature is lower than 10°C(50°F), the compressor stops operation and restarts when the room temperature is above 12°C(54°F).

**Optimal operation**

- To achieve optimal performance, please note the following:
  - Adjust the air flow direction correctly so that it is not towards people.
  - Adjust the temperature to achieve the highest comfort level. Do not adjust the unit to excessive temperature levels.
  - Close doors and windows on COOL or HEAT modes, or performance may be reduced.
  - Use TIMER ON button on the remote controller to select a time you want to start your air conditioner.
  - Do not put any object near air inlet or air outlet, as the efficiency of the air conditioner may be reduced and the air conditioner may stop running.
  - Clean the air filter periodically, otherwise cooling or heating performance may be reduced.
- Do not operate unit with horizontal louvre in closed position.

## Care and Maintenance

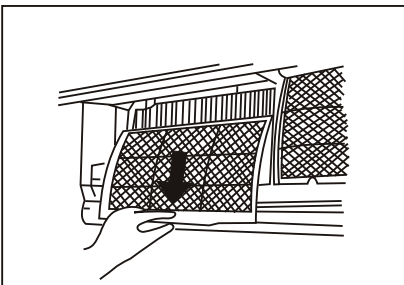
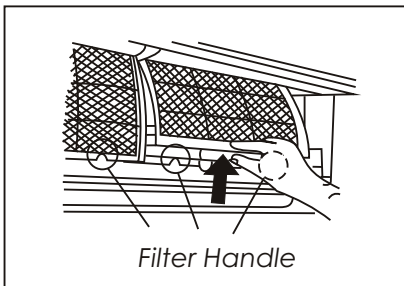
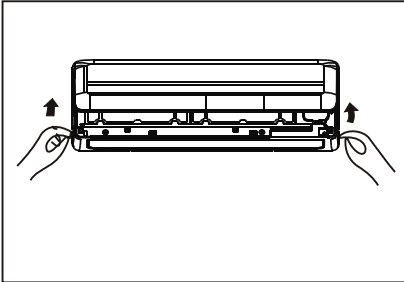

### Before maintenance

- Turn the system off before cleaning. To clean, wipe with a soft, dry cloth. Do not use bleach or abrasives.

**NOTE: Power supply must be disconnectd before cleaning the indoor unit.**

### CAUTIONS

- A cloth dampened with cold water may be used on the indoor unit if it is very dirty. Then wipe it with a dry cloth.
- Do not use a chemically treated cloth or duster to clean the unit.
- Do not use benzine, thinner, polishing powder, or similar solvents for cleaning. These may cause the plastic surface to crack or deform.
- Never use water hotter than 40°C/104°F to clean the front panel, it could cause deformation or discoloration.

### Cleaning the air filter and air freshening filter

A clogged air filter reduces the cooling efficiency of this unit. Please clean the filter once every 2 weeks.

1. Lift the indoor unit panel up to an angle until it stops with a clicking sound. For some models, please use suspension bars to prop up the panel.
2. Take hold of the handle of the air filter and lift it up slightly to take it out from the filter holder, then pull it downwards.
3. Remove the AIR FILTER from the indoor unit.  
Clean the AIR FILTER once two weeks.  
Clean the AIR FILTER with a vacuum cleaner or water, then dry in cool place.

**CARE AND MAINTENANCE**

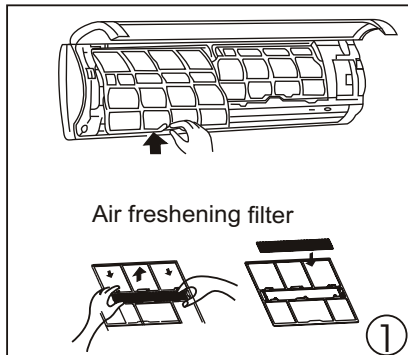

Air freshening filter

4. Remove the Air Freshening Filters from supporting frame (The solution to disassemble may vary with different filters. Refer to 1 and 2. Clean the air freshening filter at least once a month, and replace it every 4-5 months.

Clean it with vacuum cleaner, then dry it in cool place.

- ⚠ For the models with plasma, do not touch the plasma within 10 minutes after you open the panel.
5. Install the air freshening filter back into position.
  6. Insert the upper portion of air filter back into the unit, taking care that the left and right edges line up correctly and place filter into position.

**Replacement of air filter and air freshening filter**

1. Remove the air filter.
2. Remove the air freshening filter.
3. Install a new air freshening filter.
4. Reinstall the air filter and securely close the front panel.

**Preparation for extended non-operation**

If you plan to idle the unit for a long time, perform the following:

- (1) Clean the indoor unit and filters.
- (2) Operate the fan for about half a day to dry the inside of the unit.
- (3) Stop the air conditioner and disconnect power.
- (4) Remove the batteries from the remote controller.

The outdoor unit requires periodic maintenance and cleaning. Do not attempt to do this yourself. Contact your dealer or service provider.

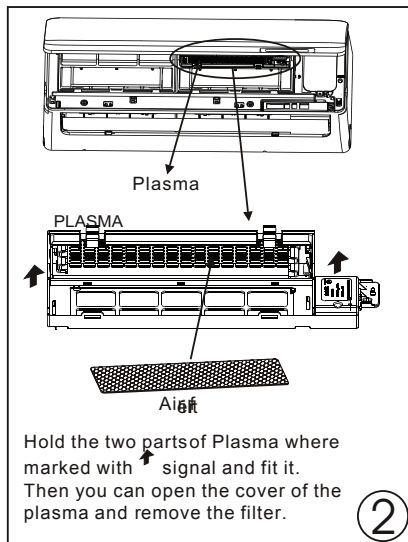

Plasma

PLASMA

Air filter

Hold the two parts of Plasma where marked with ↑ signal and fit it. Then you can open the cover of the plasma and remove the filter.

**Pre-season inspection**

- Check that the wiring is not broken off or disconnected.
- Clean the indoor unit and filters.
- Check that the air filter is installed.
- Check if the air outlet or inlet is blocked after the air conditioner has not been used for a long time.

**⚠ Caution**

- Do not touch the metal parts of the unit when removing the filter. Injuries can occur when handling sharp metal edges.
- Do not use water to clean inside the air conditioner. Exposure to water can destroy the insulation, leading to possible electric shock.
- When cleaning the unit, first make sure that the power and circuit breaker are turned off.
- Do not wash air filter with hot water at more than 40°C/104°F. Shake off moisture completely and dry it in the shade. Do not expose directly to the sun, it may shrink.

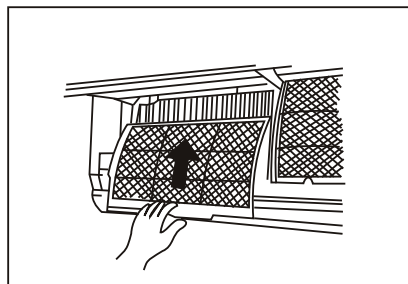
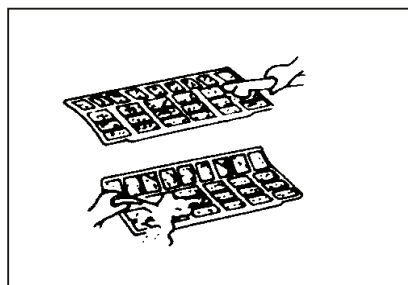

**TROUBLESHOOTING TIPS****Normal function of the air conditioner**

The following events may occur during normal operation.

**1. Protection of the air conditioner.****Compressor protection**

- The compressor can't restart for 3-4 minutes after it stops.

**• Anti-cold air (Cooling and heating models only)**

The unit is designed not to blow cold air on HEAT mode, when the indoor heat exchanger is in one of the following three situations and the set temperature has not been reached.

- A) When heating has just started.
- B) Defrosting.
- C) Low temperature heating.

The indoor or outdoor fan stop running when defrosting (Cooling and heating models only).

**• Defrosting (Cooling and heating models only)**

Frost may be generated on the outdoor unit during heat cycle when outdoor temperature is low and humidity is high resulting in lower heating efficiency of the air conditioner.

- Under this condition air conditioner will stop heating operation and start defrosting automatically.
- The time to defrost may vary from 4 to 10 minutes according to the outdoor temperature and the amount of frost built up on the outdoor unit.

**2. A white mist coming out from the indoor unit**

- A white mist may generate due to a large temperature difference between air inlet and air outlet on COOL mode in an indoor environment that has a high relative humidity.
- A white mist may generate due to moisture generated from defrosting process when the air conditioner restarts in HEAT mode operation after defrosting.

**3. Low noise of the air conditioner**

- You may hear a low hissing sound when the compressor is running or has just stopped running. It is the sound of the refrigerant flowing or coming to a stop.
- You can also hear a low "squeak" sound when the compressor is running or has just stopped running. This is caused by heat expansion and cold contraction of the plastic parts in the unit when the temperature is changing.
- A noise may be heard due to louver restoring to its original position when power is turned on.

**4. Dust is blown out from the indoor unit.**

This is a normal condition when the air conditioner has not been used for a long time or during first use of the unit.

**5. A peculiar smell comes out from the indoor unit.**

This is caused by the indoor unit giving off smells permeated from building material, from furniture, or smoke.

**6. The air conditioner turns to FAN only mode from COOL or HEAT (For cooling and heating models only) mode.**

When indoor temperature reaches the temperature setting on air conditioner, the compressor will stop automatically, and the air conditioner turns to FAN only mode. The compressor will start again when the indoor temperature rises on COOL mode or falls on HEAT mode (For cooling and heating models only) to the set point.

## **TROUBLESHOOTING TIPS**

---

### **7. The air conditioner runs Anti-mildew function after turning off the unit.**

When turning off the unit under COOL(AUTO COOL, FORCED COOL) and DRY mode, the air conditioner will run Anti-mildew function for 7-10 minutes, if turns off on HEAT mode, the unit will continue operating for about 30 seconds at LOW fan speed, then stop the operation and turn off the unit automatically. Under Anti-mildew operation, do not restart the air conditioner until the unit is completely off.

### **8. Dripping water may generate on the surface of the indoor unit when cooling in a high relative humidity (relative humidity higher than 80%). Adjust the horizontal louver to the maximum air outlet position and select HIGH fan speed.**

### **9. Heating mode (For cooling and heating models only)**

The air conditioner draws in heat from the outdoor unit and releases it via the indoor unit during heating operation. When the outdoor temperature falls, heat drawn in by the air conditioner decreases accordingly. At the same time, heat loading of the air conditioner increases due to larger difference between indoor and outdoor temperature. If a comfortable temperature can't be achieved by the air conditioner, we suggest you use a supplementary heating device.

### **10. Auto-restart function**

- Power failure during operation will stop the unit completely.
- For the unit without Auto-restart feature, when the power restores, the OPERATION indicator on the indoor unit starts flashing. To restart the operation, push the ON/OFF button on the remote controller. For the unit with Auto-restart feature, when the power restores, the unit restarts automatically with all the previous settings preserved by the memory function.

### **11. Clean filter reminder function(Optional)**

After 24 hours of operation, the indoor display window will display and flash 'CL', this feature is a reminder to clean the Air Filter for more efficient operation. After 15 seconds, the system will revert back to the previous display again. When the 'CL' indicator appears and flashes, please press the LED button on remote controller for 4 times or press the Manual control button for 3 or more times to clear the registered hours, otherwise the 'CL' indicator will display and flash again for another 15 seconds at the next time of starting the unit.

**TROUBLESHOOTING TIPS**

**Troubleshooting guide**

<b>Trouble</b>	OPERATION(RUN) indicator or other indicators continue flashing.	The unit may stop operation or continue to run in a safety condition (depending on models). Waiting for about 10 minutes, the fault may be recovered automatically, if not, disconnect the power and then connect it again. If the problem still exists, disconnect the power and contact the nearest customer service center.
	If one of the following code appears on the display area : E0,E1,E2,E3.....or P0,P1,P2, P3....., or F1,F2,F3.....	
	Fuse blows frequently or circuit breaker trips frequently .	Stop the air conditioner immediately, disconnect the power and contact the nearest customer service center.
	Other objects or water fall into the air conditioner. Bad odors are smelled or abnormal sounds are heard.	

<b>Malfunctions</b>	<b>Cause</b>	<b>What should be done?</b>
<b>Unit does not start</b>	Power cut	Wait for power to be restored.
	Unit may have become Unplugged.	Check that plug is securely in wall receptacle.
	Fuse may have blown.	Replace the fuse.
	Battery in Remote controller may have been exhausted.	Replace the battery.
	The time you have set with timer is incorrect.	Wait or cancel timer setting.
<b>Unit not cooling or heating (Cooling/ heating models only) room very well while air flowing out from the air conditioner</b>	Inappropriate temperature setting.	Set temperature correctly. For detailed method please refer to "Using remote control" section.
	Air filter is blocked.	Clean the air filter.
	Doors or Windows are open.	Close the doors or windows.
	Air inlet or outlet of indoor or outdoor unit has been blocked.	Clear obstructions away first, then restart the unit.
	Compressor 3 minutes protection has been activated.	Wait.

If the trouble has not been corrected, please contact a local dealer or the nearest customer service center. Be sure to inform them of the detailed malfunctions and unit model number.

**Notes: Do not attempt to repair the unit yourself.  
Always consult an authorized service provider.**





**LIMITED EXPRESS WARRANTY**

**Congratulations on purchasing your new HVAC equipment. It's been designed for long life and reliable service, and is backed by one of the strongest warranties in the industry. Your unit automatically qualifies for the warranty coverage listed below, providing you keep your proof of purchase (receipt) for the equipment and meet the warranty conditions.**

**LIMITED ONE (2) YEAR EXPRESS WARRANTY**

MARS warrants all parts of the VMH Series Ductless Mini-Split to be free from defects in workmanship and materials for normal use and maintenance for two (2) years from the date of purchase by the original consumer for the original installation. This Express Limited Warranty applies only when the Ductless Mini-Split is installed as a complete matched system: outdoor unit and indoor unit, and only when the system is installed per MARS installation instructions and in accordance with all local, state and national codes for normal use.

**LIMITED 3rd to 7th YEAR EXPRESS WARRANTY**

The compressor only is warranted to be free from defects in workmanship and materials for normal use and maintenance for five (5) additional years, for a total of seven (7) years from the date of purchase by the original consumer for the original installation. This Express Limited Warranty applies only when the Ductless Mini-Split is installed as a complete matched system: outdoor unit and indoor unit, and only when the system is installed per MARS installation instructions and in accordance with all local, state and national codes for normal use.

**EXCEPTIONS**

The Limited Express Warranty does not cover normal maintenance—MARS recommends that regular inspection/maintenance be performed at least once a season and proof of maintenance be kept. Additionally, labor charges, transportation charges for replacement parts, replacement of refrigerant or filters, any other service calls/repairs are not covered by this Limited Warranty. It also does not cover any portion or component of the system that is not supplied by MARS, regardless of the cause of failure of such portion or component.

**CONDITIONS FOR WARRANTY COVERAGE**

- Unit must be operated according to MARS operating instructions included with the unit and cannot have been subjected to accident, alteration, improper repair, neglect or misuse, or an act of God (such as a flood)
- Installation was done by a trained, licensed or otherwise qualified HVAC dealer/contractor
- Performance cannot be impaired by use of any product not authorized by MARS, or by any adjustments or adaptations to components
- Serial numbers and/or rating plate have not been altered or removed
- Damage has not been a result of inadequate wiring or voltage conditions, use during brown-out conditions, or circuit interruptions
- Air flow around any section of the unit has not been restricted
- Unit remains in the original installation
- Unit was not purchased over the internet

**DURATION OF WARRANTY & REGISTRATION**

The warranty begins on the date of purchase by the original consumer. The consumer must retain a receipted bill of sale as proof of warranty period. Without this proof, the express warranty begins on the date of shipment from the factory.

**REMEDY PROVIDED BY THE LIMITED EXPRESS WARRANTY**

The sole remedy under the Limited Warranty is replacement of the defective part. If replacement parts are required within the period of this warranty, MARS replacement parts shall be used; any warranty on the replacement part(s) shall not affect the applicable original unit warranty. Ready access to the unit for service is the owner's responsibility. Labor to diagnose and replace the defective part is not covered by this Limited Express Warranty. If for any reason the replacement part/product is no longer available during the warranty period, MARS shall have the right to allow a credit in the amount of the current suggested retail price of the part/product instead of providing repair or replacement.

**LIMITATION OF LIABILITY**

1. There are no other express or implied warranties. MARS makes no warranty of merchantability. We do not warrant that the unit is suitable for any particular purpose or can be used in buildings or rooms of any particular size or condition except as specifically provided in this document. There are no other warranties, express or implied, which extend beyond the description in this document.
2. All warranties implied by law are limited in duration to the seven-year term of the parts warranty. Your exclusive remedy is limited to the replacement of defective parts. **We will not be liable for any consequential or incidental damages caused by any defect in this unit.**
3. This warranty gives you specific legal rights and you may also have other rights which vary from state to state. Some states do not allow limitation on how long an implied warranty lasts or do not allow the exclusion or limitation of incidental or consequential damages, so the above limitations or exclusions may not apply to you.
4. No warranties are made for units sold outside the continental United States and Canada. Your distributor or final seller may provide a warranty on units sold outside these areas.
5. MARS will not be liable for damages if our performance regarding warranty resolution is delayed by events beyond our control including accident, alteration, abuse, war, government restrictions, strikes, fire, flood, or other acts of God.

**HOW TO OBTAIN WARRANTY SERVICE OR PARTS**

If you have a warranty claim, notify your installer promptly. If the installer does not remedy your claim, write to MARS, 1900 Wellworth Ave., Jackson MI 49203. Enclose a report of inspection by your installer or service person. Include model number, serial number, and date of purchase.

**Owner responsibilities are set forth in the instruction manual—read it carefully.**

**Please visit [www.marsdelivers.com](http://www.marsdelivers.com) to register your new product**



**KEEP THIS INFORMATION AS A RECORD OF YOUR PURCHASE**

INDOOR UNIT	OUTDOOR UNIT	INSTALLATION
Model Number	Model Number	Installer Name
Serial Number	Serial Number	Phone No./Contact Info
Date of Purchase		Date Installation Completed

**Remember to retain your bill of sale as proof of warranty period.**

---

Due to ongoing product improvements, specifications and dimensions are subject to change and correction without notice or incurring obligations. Determining the application and suitability for use of any product is the responsibility of the installer. Additionally, the installer is responsible for verifying dimensional data on the actual product prior to beginning any installation preparations.

Incentive and rebate programs have precise requirements as to product performance and certification. All products meet applicable regulations in effect on date of manufacture; however, certifications are not necessarily granted for the life of a product. Therefore, it is the responsibility of the applicant to determine whether a specific model qualifies for these incentive/rebate programs.



1900 Wellworth Ave., Jackson, MI 49203 • Ph. 517-787-2100 • [www.comfort-aire.com](http://www.comfort-aire.com) • [www.century-hvac.com](http://www.century-hvac.com)



[www.marsdelivers.com](http://www.marsdelivers.com) • [www.heatcontroller.com](http://www.heatcontroller.com)